

# Polyester floor-standing enclosures

Thalassa PLA, PLAT, PLAZ, PLAZT, Introduction

The **floor-standing enclosures** are made of **polyester reinforced with fibreglass**, moulded by hot compression. High resistance to corrosion in harsh environments, it maintains its mechanical and insulation properties.

This range can be configured according to your needs

4 different services available:



Assemble to order



Mounting of standard accessories



Painting



Machining



New Bigger dimensions

2000 mm height and 620 mm depth dimensions have been included to fit industry and infrastructure demands for motor control, power distribution, electronics or telecom applications.

PLAT version



**Ventilation**

- Open top with canopy allows passive ventilation.



**Easy**

- Various bosses for M8 inserts.

PLAZ version



**Open bottom**

- Big open bottom to be mounted directly on the floor or on a plinth.



**Smart**

- Plain mounting plate installed on step slides and compulsory adapter plates in all the enclosures with open bottom part.

PLAZT version



**Easy**

- Door opening to 180°.



**Resistant**

- Anti lever security system..

See page 522 for details or consult our web site [www.se.com](http://www.se.com)



Prolonged exposure to UV radiation, wind and rain can cause aesthetics changes in the external surface of the enclosure. Without affecting the technical properties according to IEC 62208. For long exposure applications, it is recommended to use painted enclosures available through the P&S offer.



Class II



Characteristics	PLA version	PLAT version	PLAZ version	PLAZT version
<b>Characteristics</b>	<p><b>Completely sealed enclosure</b> Enclosure obtained by assembling:</p> <ul style="list-style-type: none"> <li>• 1 sealed top part,</li> <li>• 1 sealed bottom part,</li> <li>• 2 side parts,</li> <li>• 1 or 2 rear panels (according to width),</li> <li>• 1 or 2 doors (according to width).</li> <li>• Locking system with handle with a 5 mm double bar insert block, included in the standard supply. Other blocks with inserts or barrels and keys optionally available.</li> <li>• Door opening to 120°.</li> </ul>	<p><b>Enclosure with ventilated canopy</b> Enclosure obtained by assembling:</p> <ul style="list-style-type: none"> <li>• 1 open top part with canopy,</li> <li>• 1 sealed bottom part,</li> <li>• 2 side parts,</li> <li>• 1 or 2 rear panels (according to width),</li> <li>• 1 or 2 doors (according to width).</li> <li>• Locking system with handle with a 5 mm double bar insert block, included in the standard supply. Other blocks with inserts or barrels and keys optionally available.</li> <li>• Door opening to 120°.</li> </ul>	<p><b>Enclosure with open bottom</b> Enclosure obtained by assembling:</p> <ul style="list-style-type: none"> <li>• 1 sealed top part,</li> <li>• 1 plinth-type open bottom part,</li> <li>• 2 side parts,</li> <li>• 1 or 2 rear panels (according to width),</li> <li>• 1 or 2 doors (according to width).</li> <li>• Locking system with handle with a 5 mm double bar insert block, included in the standard supply. Other blocks with inserts or barrels and keys optionally available.</li> <li>• Door opening to 120°.</li> </ul>	<p><b>Enclosure with open bottom and ventilated canopy</b> Enclosure obtained by assembling:</p> <ul style="list-style-type: none"> <li>• 1 open top part with canopy,</li> <li>• 1 plinth-type open bottom part,</li> <li>• 2 side parts,</li> <li>• 1 or 2 rear panels (according to width),</li> <li>• 1 or 2 doors (according to width).</li> <li>• Locking system with handle with a 5 mm double bar insert block. Other blocks with inserts or barrels and keys optionally available.</li> <li>• Door opening to 180°.</li> <li>• Anti-lever system to help prevent forcing of the door.</li> </ul>
<b>Material</b>	<ul style="list-style-type: none"> <li>• Polyester reinforced with fibreglass</li> </ul>			
<b>Finish</b>	<ul style="list-style-type: none"> <li>• Moulded by hot compression: The pieces have an excellent finish on both sides and can include numerous bosses for accommodating inserts and mounting or cable management accessories</li> </ul>			
<b>Colour</b>	<ul style="list-style-type: none"> <li>• RAL 7035 grey</li> </ul>			
<b>Ingress protection rating</b>	IP65 according to IEC 60529	<ul style="list-style-type: none"> <li>• IP44 according to IEC 60529</li> <li>• IP54 with 1 or 2 internal grilles, ref. <b>NSYCAG125LPF</b>, to be ordered separately.</li> </ul>	IP54 according to IEC 60529	<ul style="list-style-type: none"> <li>• IP44 according to IEC 60529</li> <li>• IP54 with 1 or 2 internal grilles, ref. <b>NSYCAG125LPF</b>, to be ordered separately</li> </ul>
<b>Mechanical protection rating</b>	IK10 (20 joules) plain door - IEC62262 and IK08 glazed door			
<b>Insulation</b>	<ul style="list-style-type: none"> <li>• Class II according to IEC 60950-1 if the mounting process follow the included mounting instructions sheet</li> </ul>			
<b>Certifications</b>	<ul style="list-style-type: none"> <li>• UL 508A/CAN-CSA 22</li> <li>• single door: NEMA types 1, 2, 3, 3R, 3S, 5, 12 and 13</li> <li>• double door: NEMA types 1, 2, 12 and 13</li> <li>• Bureau Veritas Marine</li> <li>• IEC 62208</li> </ul>	<ul style="list-style-type: none"> <li>• IEC 62208</li> </ul>		
<b>Installation</b>	<ul style="list-style-type: none"> <li>• Indoor use only. For outdoor use, must install a canopy</li> </ul>	<ul style="list-style-type: none"> <li>• Outdoor or indoor installation</li> </ul>		
	<ul style="list-style-type: none"> <li>• Direct fixing to the floor or by means of a plinth with a height of 60 mm, as an option, see <a href="#">page 202</a></li> <li>• Possibility of fixing on a semi-embedded plinth, see <a href="#">page 202</a></li> <li>• Optional wall fixing lugs</li> </ul>		<ul style="list-style-type: none"> <li>• The open bottom part forms a 60 mm plinth which is fixed to the floor directly or by means of an optional fixing frame, see <a href="#">page 204</a>, or else it is installed on a semi-embedded plinth, see <a href="#">page 204</a></li> </ul>	
<b>Options</b>	<ul style="list-style-type: none"> <li>• The versions with glassed door must be protected against the direct sun shine to avoid greenhouse effect</li> <li>• Anti-posting door upon request</li> </ul>			

**PHD - Applicative and customised solutions:**  
See the Polyester Heavy Duty offer in the Applicative and customised solutions, [page 406](#).



**Indoor and Outdoor:**  
For outdoor use, must install a canopy.

Completely sealed enclosures, IP65



PLA



PLA



PLAZ

Dimensions (mm)				Completely sealed enclosures, IP65		Enclosures with open bottom part, IP54
Height	Width	Depth	N° of doors	Plain	Glazed**	Plain
500	500	320	1	NSYPLA553G	NSYPLA553TG	NSYPLAZ553G
500	500	420	1	NSYPLA554G	NSYPLA554TG	NSYPLAZ554G
500	750	320	1	NSYPLA573G	NSYPLA573TG	NSYPLAZ573G
500	750	420	1	NSYPLA574G	NSYPLA574TG	NSYPLAZ574G
500	1000	320	2	NSYPLA5103G	NSYPLA5103TG	NSYPLAZ5103G
500	1000	420	2	NSYPLA5104G	NSYPLA5104TG	NSYPLAZ5104G
500	1250	320	2	NSYPLA5123G	NSYPLA5123TG	NSYPLAZ5123G
500	1250	420	2	NSYPLA5124G	NSYPLA5124TG	NSYPLAZ5124G
750	500	320	1	NSYPLA753G	NSYPLA753TG	NSYPLAZ753G
750	500	420	1	NSYPLA754G	NSYPLA754TG	NSYPLAZ754G
750	750	320	1	NSYPLA773G	NSYPLA773TG	NSYPLAZ773G
750	750	420	1	NSYPLA774G	NSYPLA774TG	NSYPLAZ774G
750	750	620	1	NSYPLA776G	NSYPLA776TG	NSYPLAZ776G
750	1000	320	2	NSYPLA7103G	NSYPLA7103TG	NSYPLAZ7103G
750	1000	420	2	NSYPLA7104G	NSYPLA7104TG	NSYPLAZ7104G
750	1250	320	2	NSYPLA7123G	NSYPLA7123TG	NSYPLAZ7123G
750	1250	420	2	NSYPLA7124G	NSYPLA7124TG	NSYPLAZ7124G
1000	500	320	1	NSYPLA1053G	NSYPLA1053TG	NSYPLAZ1053G
1000	500	420	1	NSYPLA1054G	NSYPLA1054TG	NSYPLAZ1054G
1000	750	320	1	NSYPLA1073G	NSYPLA1073TG	NSYPLAZ1073G
1000	750	420	1	NSYPLA1074G	NSYPLA1074TG	NSYPLAZ1074G
1000	1000	320	2	NSYPLA10103G	NSYPLA10103TG	NSYPLAZ10103G
1000	1000	420	2	NSYPLA10104G	NSYPLA10104TG	NSYPLAZ10104G
1000	1250	320	2	NSYPLA10123G	NSYPLA10123TG	NSYPLAZ10123G
1000	1250	420	2	NSYPLA10124G	NSYPLA10124TG	NSYPLAZ10124G
1250	500	320	1	NSYPLA1253G	NSYPLA1253TG	NSYPLAZ1253G
1250	500	420	1	NSYPLA1254G	NSYPLA1254TG	NSYPLAZ1254G
1250	750	320	1	NSYPLA1273G	NSYPLA1273TG	NSYPLAZ1273G
1250	750	420	1	NSYPLA1274G	NSYPLA1274TG	NSYPLAZ1274G
1250	750	620	1	NSYPLA1276G	NSYPLA1276TG	NSYPLAZ1276G
1250	1000	320	2	NSYPLA12103G	NSYPLA12103TG	NSYPLAZ12103G
1250	1000	420	2	NSYPLA12104G	NSYPLA12104TG	NSYPLAZ12104G
1250	1250	320	2	NSYPLA12123G	NSYPLA12123TG	NSYPLAZ12123G
1250	1250	420	2	NSYPLA12124G	NSYPLA12124TG	NSYPLAZ12124G
1250	1250	620	2	NSYPLA12126G	NSYPLA12126TG	NSYPLAZ12126G
1500	500	320	1	NSYPLA1553G	NSYPLA1553TG	NSYPLAZ1553G
1500	500	420	1	NSYPLA1554G	NSYPLA1554TG	NSYPLAZ1554G
1500	750	320	1	NSYPLA1573G	NSYPLA1573TG	NSYPLAZ1573G
1500	750	420	1	NSYPLA1574G	NSYPLA1574TG	NSYPLAZ1574G
1500	750	620	1	NSYPLA1576G	NSYPLA1576TG	NSYPLAZ1576G
1500	1000	320	2	NSYPLA15103G	NSYPLA15103TG	NSYPLAZ15103G
1500	1000	420	2	NSYPLA15104G	NSYPLA15104TG	NSYPLAZ15104G
1500	1250	320	2	NSYPLA15123G	NSYPLA15123TG	NSYPLAZ15123G
1500	1250	420	2	NSYPLA15124G	NSYPLA15124TG	NSYPLAZ15124G
1500	1250	620	2	NSYPLA15126G	NSYPLA15126TG	NSYPLAZ15126G
2000	750	420	2*	NSYPLA2074G	NSYPLA2074TG	NSYPLAZ2074G

\*Two doors in vertical.

\*\*Recommended to protect against the direct sun radiation.

**PHD - Applicative and customised solutions:**

See the Polyester Heavy Duty offer in the applicative and customised solutions, [page 406](#).

Technical changes reserved. Information provided without guarantee. Images are for illustrative purposes only.



**Indoor and Outdoor:**  
For outdoor use, must install a canopy.

Enclosures with ventilated canopy, IP44



**PLAT**

Enclosures with open bottom part and ventilated canopy, IP44



**PLA2T**

Dimensions (mm)				Plain	Plain
Height	Width	Depth	N° of doors		
500	500	320	1	NSYPLAT553G	NSYPLAZT553G
500	500	420	1	NSYPLAT554G	NSYPLAZT554G
500	750	320	1	NSYPLAT573G	NSYPLAZT573G
500	750	420	1	NSYPLAT574G	NSYPLAZT574G
500	1000	320	2	NSYPLAT5103G	NSYPLAZT5103G
500	1000	420	2	NSYPLAT5104G	NSYPLAZT5104G
500	1250	320	2	NSYPLAT5123G	NSYPLAZT5123G
500	1250	420	2	NSYPLAT5124G	NSYPLAZT5124G
750	500	320	1	NSYPLAT753G	NSYPLAZT753G
750	500	420	1	NSYPLAT754G	NSYPLAZT754G
750	750	320	1	NSYPLAT773G	NSYPLAZT773G
750	750	420	1	NSYPLAT774G	NSYPLAZT774G
750	750	620	1	NSYPLAT776G	NSYPLAZT776G
750	1000	320	2	NSYPLAT7103G	NSYPLAZT7103G
750	1000	420	2	NSYPLAT7104G	NSYPLAZT7104G
750	1250	320	2	NSYPLAT7123G	NSYPLAZT7123G
750	1250	420	2	NSYPLAT7124G	NSYPLAZT7124G
1000	500	320	1	NSYPLAT1053G	NSYPLAZT1053G
1000	500	420	1	NSYPLAT1054G	NSYPLAZT1054G
1000	750	320	1	NSYPLAT1073G	NSYPLAZT1073G
1000	750	420	1	NSYPLAT1074G	NSYPLAZT1074G
1000	1000	320	2	NSYPLAT10103G	NSYPLAZT10103G
1000	1000	420	2	NSYPLAT10104G	NSYPLAZT10104G
1000	1250	320	2	NSYPLAT10123G	NSYPLAZT10123G
1000	1250	420	2	NSYPLAT10124G	NSYPLAZT10124G
1250	500	320	1	NSYPLAT1253G	NSYPLAZT1253G
1250	500	420	1	NSYPLAT1254G	NSYPLAZT1254G
1250	750	320	1	NSYPLAT1273G	NSYPLAZT1273G
1250	750	420	1	NSYPLAT1274G	NSYPLAZT1274G
1250	750	620	1	NSYPLAT1276G	NSYPLAZT1276G
1250	1000	320	2	NSYPLAT12103G	NSYPLAZT12103G
1250	1000	420	2	NSYPLAT12104G	NSYPLAZT12104G
1250	1250	320	2	NSYPLAT12123G	NSYPLAZT12123G
1250	1250	420	2	NSYPLAT12124G	NSYPLAZT12124G
1250	1250	620	2	NSYPLAT12126G	NSYPLAZT12126G
1500	500	320	1	NSYPLAT1553G	NSYPLAZT1553G
1500	500	420	1	NSYPLAT1554G	NSYPLAZT1554G
1500	750	320	1	NSYPLAT1573G	NSYPLAZT1573G
1500	750	420	1	NSYPLAT1574G	NSYPLAZT1574G
1500	750	620	1	NSYPLAT1576G	NSYPLAZT1576G
1500	1000	320	2	NSYPLAT15103G	NSYPLAZT15103G
1500	1000	420	2	NSYPLAT15104G	NSYPLAZT15104G
1500	1250	320	2	NSYPLAT15123G	NSYPLAZT15123G
1500	1250	420	2	NSYPLAT15124G	NSYPLAZT15124G
1500	1250	620	2	NSYPLAT15126G	NSYPLAZT15126G
2000	750	420	Two doors in vertical	NSYPLAT2074G	NSYPLAZT2074G

**PHD - Applicative and customised solutions:**

See the Polyester Heavy Duty offer in the applicative and customised solutions, [page 406](#).

Technical changes reserved. Information provided without guarantee. Images are for illustrative purposes only.

## Horizontal coupling kits, 15 mm, join two enclosures mounted on ZA plinths

- For coupling two enclosures side by side.
- Coupling frame kit: Made up of a coupling kit and the fixings required for installation.
- Trim kit: Made up of two frames for aesthetic fitting of the two coupled enclosures
- Coupling kit widths: 15 mm - Join two enclosures mounted on ZA plinths
- Ingress protection rating: IP55 at the coupling point

**Note:**  
Not valid for coupling two enclosures using ZZ or ZH type plinth.

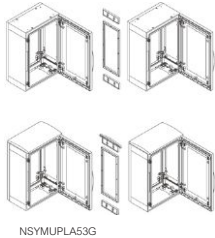

Characteristics	Depth (mm)	Height (mm)	References
Coupling frame kit 15 mm	320	500	NSYMUPLA53G
Coupling frame kit 15 mm	320	750	NSYMUPLA73G
Coupling frame kit 15 mm	320	1000	NSYMUPLA103G
Coupling frame kit 15 mm	320	1250	NSYMUPLA123G
Coupling frame kit 15 mm	320	1500	NSYMUPLA153G
Coupling frame kit 15 mm	420	500	NSYMUPLA54G
Coupling frame kit 15 mm	420	750	NSYMUPLA74G
Coupling frame kit 15 mm	420	1000	NSYMUPLA104G
Coupling frame kit 15 mm	420	1250	NSYMUPLA124G
Coupling frame kit 15 mm	420	1500	NSYMUPLA154G
Coupling frame kit 15 mm	420	2000	NSYMUPLA204G
Coupling frame kit 15 mm	620	750	NSYMUPLA76G
Coupling frame kit 15 mm	620	1250	NSYMUPLA126G
Coupling frame kit 15 mm	620	1500	NSYMUPLA156G
Trim kit for enclosure without canopy	320	-	NSYSUPLA3G
Trim kit for enclosure with canopy	320	-	NSYSUPLA3TG
Trim kit for enclosure without canopy	420	-	NSYSUPLA4G
Trim kit for enclosure with canopy	420	-	NSYSUPLA4TG

## Horizontal coupling kits 35 mm, join two enclosures mounted on ZZ or ZH plinths

- For coupling two enclosures side by side.
- Coupling frame kit: Made up of a coupling kit and the fixings required for installation.
- Trim kit: Made up of two frames for aesthetic fitting of the two coupled enclosures
- Coupling kit widths: 35 mm - Join two enclosures mounted on ZZ or ZH plinths
- Ingress protection rating: IP55 at the coupling point

**Note:**  
Not valid for coupling two enclosures using ZA plinths

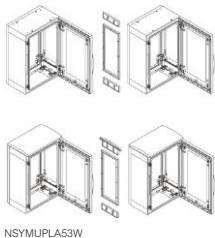

Characteristics	Depth (mm)	Height (mm)	References
Coupling frame kit 35 mm	320	500	NSYMUPLA53W
Coupling frame kit 35 mm	320	750	NSYMUPLA73W
Coupling frame kit 35 mm	320	1000	NSYMUPLA103W
Coupling frame kit 35 mm	320	1250	NSYMUPLA123W
Coupling frame kit 35 mm	320	1500	NSYMUPLA153W
Coupling frame kit 35 mm	420	500	NSYMUPLA54W
Coupling frame kit 35 mm	420	750	NSYMUPLA74W
Coupling frame kit 35 mm	420	1000	NSYMUPLA104W
Coupling frame kit 35 mm	420	1250	NSYMUPLA124W
Coupling frame kit 35 mm	420	1500	NSYMUPLA154W
Coupling frame kit 35 mm	420	2000	NSYMUPLA204W
Coupling frame kit 35 mm	620	750	NSYMUPLA76W
Coupling frame kit 35 mm	620	1250	NSYMUPLA126W
Coupling frame kit 35 mm	620	1500	NSYMUPLA156W

## Vertical coupling kit

- For coupling two enclosures on top of one another.
- Kit made up of 3.5 m of adhesive seal and the fixings required for mounting.
- Ingress protection rating: IP55 at the coupling point

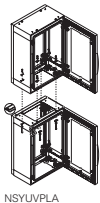

Characteristics	References
Vertical coupling kit	NSYUVPLA

## Canopy

- It can be installed in all enclosure models.
- High resistance to impacts, temperature and bad weather.
- Increases the height (A) of the enclosure by 38 mm, without modifying its width or depth.
- Material: Polyester reinforced with fibreglass
- Colour: RAL 7035 grey
- Installation: Essential for outdoor use

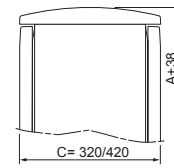

**Supply:**  
Delivered with the fixings required for installation



NSYTJPLA53G

Characteristics	Width (mm)	Depth (mm)	References
Canopy	500	320	NSYTJPLA53G
Canopy	500	420	NSYTJPLA54G
Canopy	750	320	NSYTJPLA73G
Canopy	750	420	NSYTJPLA74G
Canopy	750	620	NSYTJPLA76G
Canopy	1000	320	NSYTJPLA103G
Canopy	1000	420	NSYTJPLA104G
Canopy	1250	320	NSYTJPLA123G
Canopy	1250	420	NSYTJPLA124G
Canopy	1250	620	NSYTJPLA126G

## Wall fixing lugs



NSYFMPLA

- Drilling positions and marks inside the side panels.
- Material: Carbon steel with passivated zinc-coated
  - Maximum load: 180 kg including weight of enclosure
- Fixing:** Fixing on the sides by four or six lugs in horizontal position (six lugs for enclosures with height  $\geq$  1000 mm)  
10 mm fixing distance on the rear of the enclosure plane

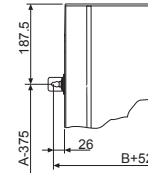

**Supply:**  
Set of six lugs and fixings

Characteristics	References
Wall fixing lugs	NSYFMPLA

## PLAZ PLAZT Cable entry plate

- Easy drilling in specific customised version.
- Incompatibility with: Adapter plates, step slides, internal door and chassis for modular distribution.
- Material: Polyester reinforced with fibreglass
- Thickness: 4 mm

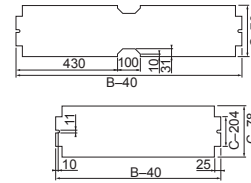

**Supply:**  
Delivered with the fixings required for installation



NSYECPLAZ53G

Characteristics	Width (mm)	Depth (mm)	References
Cable entry plate	500	320	NSYECPLAZ53G
Cable entry plate	500	420	NSYECPLAZ54G
Cable entry plate	750	320	NSYECPLAZ73G
Cable entry plate	750	420	NSYECPLAZ74G
Cable entry plate	750	620	NSYECPLAZ76G
Cable entry plate	1000	320	NSYECPLAZ103G
Cable entry plate	1000	420	NSYECPLAZ104G
Cable entry plate	1250	320	NSYECPLAZ123G
Cable entry plate	1250	420	NSYECPLAZ124G
Cable entry plate	1250	620	NSYECPLAZ126G

## Renovation and anti graffiti paint

- Paint kit with two components (base 80 % + hardener 20 %)
- Specially designed for polyester enclosures, for their renovation and/or as prevention to allow easy removal of graffiti.
- Colour: RAL 7035 grey

### Supply: NSYAUPG1G

The 1 kg reference includes one pot with 800 g of base paint and 200 g of hardener (It is enough to paint a surface of around 5 m<sup>2</sup>)

### Supply: NSYAUPG5G

The 5 kg reference includes one pot with 4 kg of base paint and 1 kg of hardener (It is enough to paint a surface of around 25 m<sup>2</sup>)



NSYAUPG1G

Characteristics	References
Renovation and anti graffiti paint	NSYAUPG1G
Renovation and anti graffiti paint	NSYAUPG5G

**Supply:**  
1 kg

Characteristics	References
Renovation and anti graffiti paint solvent	NSYAUPGS

- Solvent bottles to be used as a paint thinner or to clean brushes.



<b>Characteristics</b>	<b>ZA plinths</b>
	<ul style="list-style-type: none"> <li>The frontal parts of the plinth (front and rear) have two stainless steel screws protected by a plastic cap; these screws, which can be accessed from the outside, make it possible (using an Allen key) to open and remove the frontal parts for easier cable installation.</li> <li>In stacked position, the bottom plinth can be partially buried.</li> <li>It is provided with one or two reinforcement cross rails, adjustable to adapt to the position of the cables.</li> </ul>
<b>Material</b>	Polyester reinforced with fibreglass
<b>Colour</b>	RAL 7035 grey
<b>Ingress protection rating</b>	IP44
<b>Mechanical protection rating</b>	IK10
<b>Fixing</b>	Four floor attachment points; The symmetry of the parts helps prevent incorrect assembly
<b>Supply</b>	The reference of the plinth contains all the accessories required for attaching the enclosure to the plinth and for stacking two plinths

For floor-standing enclosure			Plinth		Cable gland area		Height 200 mm
Width (mm)	Depth (mm)	References	Width (mm)	Depth (mm)	Width (mm)	Depth (mm)	References
500	320	NSYPLA(T)●53G	494	250	360	205	NSYZA253G
750	320	NSYPLA(T)●73G	744	250	610	205	NSYZA273G
1000	320	NSYPLA(T)●103G	994	250	860	205	NSYZA2103G
1250	320	NSYPLA(T)●123G	1244	250	1100	205	NSYZA2123G
500	420	NSYPLA(T)●54G	494	350	360	305	NSYZA254G
750	420	NSYPLA(T)●74G	744	350	610	305	NSYZA274G
1000	420	NSYPLA(T)●104G	994	350	860	305	NSYZA2104G
1250	420	NSYPLA(T)●124G	1244	350	1110	305	NSYZA2124G
750	620	NSYPLA(T)●76G	744	550	610	505	NSYZA276G
1250	620	NSYPLA(T)●126G	1244	550	1110	505	NSYZA2126G

## Cable supporting cross rail

- Description: The lateral sides of the plinth are provided with bosses for attaching cross rails with cut-out profiles, for supporting cables.

**Supply:**  
the reference of the cross rail includes all the elements required for assembly.



NSYAC320

Characteristics	For plinth	For plinth	References
Cable supporting cross rail	NSYZA253G	NSYZA254G	<b>NSYAC320</b>
Cable supporting cross rail	NSYZA273G	NSYZA274G	<b>NSYAC560</b>
Cable supporting cross rail	NSYZA2103G	NSYZA2104G	<b>NSYAC840</b>
Cable supporting cross rail	NSYZA2123G	NSYZA2124G	<b>NSYAC1080</b>

## Kit for IP54



NSYAEFZA

- Description: Makes it possible to obtain IP 54 for the plinth and the plinth enclosure connection..
- Standard: IEC 61439-1

Characteristics	References
Kit for IP54	<b>NSYAEFZA</b>

## Feet for partially buried installation



NSYAEBFZ

Description: Allows the partially buried installation of plinths before completion of the floor. The plinths are attached by four feet with a standard length of 750 mm. Possibility of horizontal adjustment of the plinth.

**Supply:**  
the kit is made up of four feet and fixings.

Characteristics	References
Feet for partially buried installation	<b>NSYAEBFZ</b>

## N plinths

Designed to be installed under the closed bottom enclosures (version PLA or PLAT).

- Material: Polyester reinforced with fibreglass
- Colour: RAL 7035 grey
- Height 60 mm

**Supply:**  
Delivered with fixings required for installation



NSYZNPLA53G

Characteristics	References
N plinths	<b>NSYZNPLA53G</b>
N plinths	<b>NSYZNPLA73G</b>
N plinths	<b>NSYZNPLA103G</b>
N plinths	<b>NSYZNPLA123G</b>
N plinths	<b>NSYZNPLA54G</b>
N plinths	<b>NSYZNPLA74G</b>
N plinths	<b>NSYZNPLA104G</b>
N plinths	<b>NSYZNPLA124G</b>

## Connectors between plinths

**Description:** Designed to allow the adaptation of a closed bottom enclosure + N plinth on a H-type partially buried plinth.

NSYPLA or NSYPLAT not for NSYPLAZ●●●

NSYZNPLA●●●

NSYAZ●●●

NSYZHPLA●●●

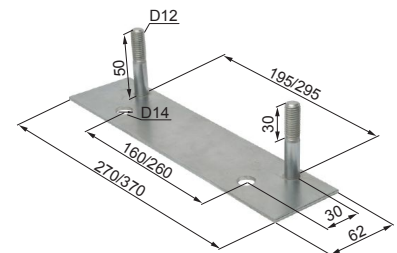
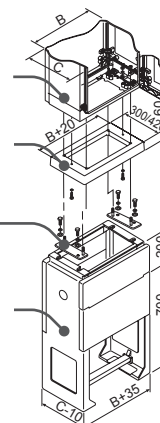

**Supply:**  
two parts for adapting the centre-to-centre distances.



NSYAZ3PLA

Characteristics	For floor-standing enclosure Depth (mm)	References
Linking parts for N plinth on 320 mm H plinth	320	<b>NSYAZ3PLA</b>
Linking parts for N plinth on 420 mm H plinth	420	<b>NSYAZ4PLA</b>



(1) For enclosures using ZZ or ZH type plinths the coupling kit to use is the **NSYMUPLA●●●W**.

<b>Characteristics</b>	<b>ZZ plinths (1)</b>
	<ul style="list-style-type: none"> <li>The frontal parts (front and rear) are removed from the inside. Removing them makes it easier to install the cables.</li> <li>The 500 mm plinth can be partially buried.</li> <li>It is provided with one or two reinforcement cross rails, adjustable to adapt to the position of the cables.</li> </ul>
<b>Material</b>	Polyester reinforced with fibreglass
<b>Colour</b>	RAL 7035 grey
<b>Ingress protection rating</b>	IP44
<b>Mechanical protection rating</b>	IK10
<b>Fixing</b>	Four floor attachment points; The symmetry of the parts helps prevent incorrect assembly
<b>Supply</b>	The reference of the plinth contains all the accessories required for attaching the enclosure to the plinth

For floor-standing enclosure			Plinth		Cable gland area		Height 200 mm	Height 500 mm
Width (mm) (B)	Depth (mm) (C)	References	Width (mm)	Depth (mm)	Width (mm)	Depth (mm)	References	References
500	320	<b>NSYPLAZ(T)●53G</b>	535	310	419	252	<b>NSYZZ253G</b>	<b>NSYZZ553G</b>
750	320	<b>NSYPLAZ(T)●73G</b>	785	310	669	252	<b>NSYZZ273G</b>	<b>NSYZZ573G</b>
1000	320	<b>NSYPLAZ(T)●103G</b>	1035	310	919	252	<b>NSYZZ2103G</b>	<b>NSYZZ5103G</b>
1250	320	<b>NSYPLAZ(T)●123G</b>	1285	310	1169	252	<b>NSYZZ2123G</b>	<b>NSYZZ5123G</b>
500	420	<b>NSYPLAZ(T)●54G</b>	535	410	419	352	<b>NSYZZ254G</b>	<b>NSYZZ554G</b>
750	420	<b>NSYPLAZ(T)●74G</b>	785	410	669	352	<b>NSYZZ274G</b>	<b>NSYZZ574G</b>
1000	420	<b>NSYPLAZ(T)●104G</b>	1035	410	919	352	<b>NSYZZ2104G</b>	<b>NSYZZ5104G</b>
1250	420	<b>NSYPLAZ(T)●124G</b>	1285	410	1169	352	<b>NSYZZ2124G</b>	<b>NSYZZ5124G</b>
750	620	<b>NSYPLAZ(T)●76G</b>	785	610	669	552	<b>NSYZZ276G</b>	-
1250	620	<b>NSYPLAZ(T)●126G</b>	1285	610	1169	552	<b>NSYZZ2126G</b>	-

## Cable supporting cross rail

- Description: The lateral sides of the plinths are provided with bosses for attaching cross rails with cut-out profiles, for supporting cables.

**Supply:**  
the reference of the cross rail includes all the elements required for assembly

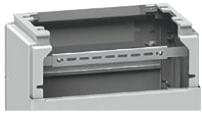

NSYAC360

Characteristics	For plinth	For plinth	For plinth	For plinth	References
Cable supporting cross rail	NSYZZ253G	NSYZZ254G	NSYZZ553G	NSYZZ554G	<b>NSYAC360</b>
Cable supporting cross rail	NSYZZ273G	NSYZZ274G	NSYZZ573G	NSYZZ574G	<b>NSYAC600</b>
Cable supporting cross rail	NSYZZ2103G	NSYZZ2104G	NSYZZ5103G	NSYZZ5104G	<b>NSYAC840</b>
Cable supporting cross rail	NSYZZ2123G	NSYZZ2124G	NSYZZ5123G	NSYZZ5124G	<b>NSYAC1120</b>

## Outside opening kit



NSYAE LZ

- Description: The 200 mm front part of the 200 and 500 mm plinths can be opened from the outside, after installing a kit made up of two locks with double bar insert.

Characteristics	References
Outside opening kit	<b>NSYAE LZ</b>

## Buriable H plinths



NSYZHPLA53G

- Front panel with a height of 170 mm, retractable, providing easy access to the inside.
- Fixed front panel with a height of 305 mm, corresponding to the finished floor height area.
- The height above the floor after built-in varies between 200 and 500 mm.
- A metal rail helps to fix the entry cables.
- Lateral uprights with pre-knock-out auxiliary output with Ø Pg 36 (48 mm).
- A pre-knock-out area is provided at the bottom of the lateral uprights for cable entry, if necessary.
- Material: Polyester reinforced with fibreglass
- Colour: RAL 7035 grey

**Supply:**  
Delivered with the fixings required for installation

**Note:**  
Dimensions, see [page 222](#)



NSYZHPLA53G

Characteristics	References
Buriable H plinths	<b>NSYZHPLA53G</b>
Buriable H plinths	<b>NSYZHPLA73G</b>
Buriable H plinths	<b>NSYZHPLA103G</b>
Buriable H plinths	<b>NSYZHPLA123G</b>
Buriable H plinths	<b>NSYZHPLA54G</b>
Buriable H plinths	<b>NSYZHPLA74G</b>
Buriable H plinths	<b>NSYZHPLA104G</b>
Buriable H plinths	<b>NSYZHPLA124G</b>

## Floor-standing frame

- Frame for direct fixing on the floor for installing open bottom enclosures (version PLAZ or PLAZT).
- Material: Passivated zinc-coated steel

**Supply:**  
Delivered with fixings required for installation

**Note:**  
Dimensions, see [page 222](#)



NSYMFPLAZ53

Characteristics	References
Floor-standing frame	<b>NSYMFPLAZ53</b>
Floor-standing frame	<b>NSYMFPLAZ73</b>
Floor-standing frame	<b>NSYMFPLAZ103</b>
Floor-standing frame	<b>NSYMFPLAZ123</b>
Floor-standing frame	<b>NSYMFPLAZ54</b>
Floor-standing frame	<b>NSYMFPLAZ74</b>
Floor-standing frame	<b>NSYMFPLAZ104</b>
Floor-standing frame	<b>NSYMFPLAZ124</b>
Floor-standing frame	<b>NSYMFPLAZ76</b>
Floor-standing frame	<b>NSYMFPLAZ126</b>

## Floor-fixing studs



NSYFSP LAZ

- Description: Set of four threaded parts and fixings, for fixing the enclosures on concrete plinths.

Characteristics	References
Floor-fixing studs	<b>NSYFSP LAZ</b>

## Internal door

- Designed for direct installation in enclosures with sealed bottom part. In the enclosures with the bottom part open, installation can be performed by ordering the necessary adapter plates, ref. **NSYPTZ●●●**.
- Two depthwise mounting positions (two positions for depthwise installation) according to the chosen M8 impressions, on the top and bottom parts of the enclosure, for fixing.
- Lock with 5 mm double bar inserts.
- Incompatibility with: Modular distribution chassis, 19" chassis, cable entry plate and door retainer, ref. **NSYRETPLAU**.
- Material: Aluminium
- Colour: RAL 7035 grey

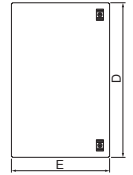

**Supply:**  
Delivered with M8 brass inserts and fixings

**Note:**  
Dimensions, see [page 222](#)



Dimensions		Internal door dimensions		References
Height (mm)	Width (mm)	D (mm)	E (mm)	
500	500	398	398	<b>NSYPAPLA55G</b>
500	750	398	648	<b>NSYPAPLA57G</b>
500	1000	398	796 (2 x 398)	2 x <b>NSYPAPLA55G</b>
500	1250	398	1046 (398 + 648)	<b>NSYPAPLA55G + NSYPAPLA57G</b>
750	500	648	398	<b>NSYPAPLA75G</b>
750	750	648	648	<b>NSYPAPLA77G</b>
750	1000	648	796 (2 x 398)	2 x <b>NSYPAPLA75G</b>
750	1250	648	1046 (398 + 648)	<b>NSYPAPLA75G + NSYPAPLA77G</b>
1000	500	898	398	<b>NSYPAPLA105G</b>
1000	750	898	648	<b>NSYPAPLA107G</b>
1000	1000	898	796 (2 x 398)	2 x <b>NSYPAPLA105G</b>
1000	1250	898	1046 (398 + 648)	<b>NSYPAPLA105G + NSYPAPLA107G</b>
1250	500	1148	398	<b>NSYPAPLA125G</b>
1250	750	1148	648	<b>NSYPAPLA127G</b>
1250	1000	1148	796 (2 x 398)	2 x <b>NSYPAPLA125G</b>
1250	1250	1148	1046 (398 + 648)	<b>NSYPAPLA125G + NSYPAPLA127G</b>
1500	500	1398	398	<b>NSYPAPLA155G</b>
1500	750	1398	648	<b>NSYPAPLA157G</b>
1500	1000	1398	796 (2 x 398)	2 x <b>NSYPAPLA155G</b>
1500	1250	1398	1046 (398 + 648)	<b>NSYPAPLA155G + NSYPAPLA157G</b>

**Supply:**  
Delivered with the fixings required for installation

**Note:**  
ref. **NSYRETPLAU** is incompatible with internal doors, modular distribution chassis, step slides, adapter plates and cable entry plates. In the event of incompatibility, use ref. **NSYRETPLA**.

## Door retainer

- Designed to adapt directly to the enclosure
- Can be installed on a door opening to the left or right indistinctly
- Material: Galvanised steel

**Supply:**  
Delivered with the fixings required for installation

**Note:**  
ref. **NSYRETPLAU** is incompatible with internal doors, modular distribution chassis, step slides, adapter plates and cable entry plates. In the event of incompatibility, use ref. **NSYRETPLA**.

Characteristics	References
Door retainer, PLA, PLAZ, PLAT versions, opening to 110°	<b>NSYRETPLA</b>
Door retainer, PLA, PLAZ, PLAT, PLAZT versions*, with 2 positions, 90° and 120°	<b>NSYRETPLAU</b>



NSYRETPLA



NSYRETPLAU

## Door switch

- NC + NO switch.
- Incompatible with the rear door and modular distribution chassis

**Supply:**  
Switch, fixing bracket and fixings

Characteristics	References
Door switch	<b>NSYSNLPLA</b>



NSYSNLPLA

## Lock with handle

- Ergonomic locking system with pivoting handle installed as standard on enclosures with ventilated canopy and/or open bottom part, with a 5 mm double bar insert block.
- Material: PA6
- Colour: RAL 7035 grey

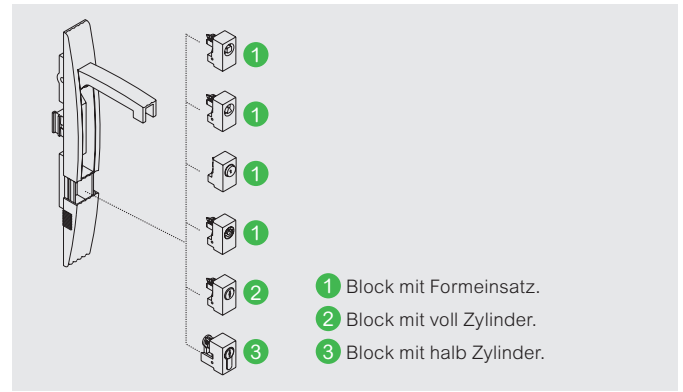

## Options for changing the form-insert blocks

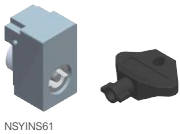

NSYINS61

Characteristics	References
6 mm square insert	NSYINS61
7 mm square insert	NSYINS71
8 mm square insert	NSYINS81
6.5 mm triangular insert	NSYINT61
8 mm triangular insert	NSYINT81
Push-button	NSYTSPLA
Double bar	NSYINDB51

## Options for changing the blocks with cylindrical barrels

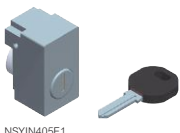

NSYIN405E1

Characteristics	References
405E key lock	NSYIN405E1
421E key lock	NSYIN421E1
455 key lock	NSYIN4551
1242E key lock	NSYIN1242E1
1332E key lock	NSYIN1332E1
2124E key lock	NSYIN2124E1
2131A key lock	NSYIN2131A1
2132A key lock	NSYIN2132A1
2331A key lock	NSYIN2331A1
2433A key lock	NSYIN2433A1
2452E key lock	NSYIN2452E1
3113A key lock	NSYIN3113A1
3122E key lock	NSYIN3122E1
3123A key lock	NSYIN3123A1
3131A1 key lock	NSYIN3131A1
3133A key lock	NSYIN3133A1
3422E key lock	NSYIN3422E1
3432E key lock	NSYIN3432E1
6101 key lock	NSYIN6101

## Options for changing the blocks with semi-cylindrical barrels

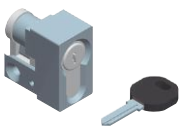

NSYIN1242E2

Characteristics	References
Spacial SF/SM 1242E key lock	NSYIN1242E2
Spacial SF/SM Adapter for DIN cylinder	NSYINDIN2
Spacial SF/SM JIS key lock	NSYINKJIS2
Spacial SF/SM Reinforced key lock	NSYINKR2
Spacial SF/SM FAC key lock	NSYINKFAC2

## Options for changing the handle lock

- Changing the handle for a handle including a padlocking device (Ø 10 mm) allowing the handle to be locked. The handle is delivered without barrel or insert block.



NSYBCMPLAG

Characteristics	References
Options for changing the handle lock	<b>NSYBCMPLAG</b>

## Options for changing the handle lock

- Spare handle lock without barrel or insert blocks. The insert or barrel are to be chosen from the option table.



NSYBCMPLAG

Characteristics	References
Options for changing the handle lock	<b>NSYEBMPLAG</b>

Type of lock	Insert references	Key references
5 mm double bar	NSYTDB5PLA	<b>NSYLDB5</b>
6 mm	NSYTC6CRN	<b>NSYLC7</b>
7 mm	NSYTC7CRN	<b>NSYLC7</b>
8 mm	NSYTC8CRN	<b>NSYLC8</b>
6.5 mm	NSYTT6CRN	<b>NSYLT8</b>
7 mm	NSYTT7CRN	<b>NSYLT8</b>
8 mm	NSYTT8CRN	<b>NSYLT8</b>

## 19" fixed chassis

**Installation:** For heights from 750 to 1500 mm, the installation requires ordering one batch of two matching uprights. If a chassis is installed in an enclosure with a greater height, it is necessary to use the suitable uprights for the size of the enclosure

- Very sturdy 19" metal chassis, designed for installation in enclosures with a width of 750 and 1250 mm.  
In the 1250 mm enclosure, the chassis is installed in the 750 mm part with an intermediate support, ref. **NSYSBPLA**.
- These chassis can be used as partial mounting plates in enclosures with higher than nominal height.
- Incompatible with the internal doors and the step slides.
- Fixed chassis made up of two uprights with fixings
- Material: Galvanised steel
- Finish: Epoxy polyester paint
- Colour: RAL 7035 grey
- Maximum load: 3 kg per unit

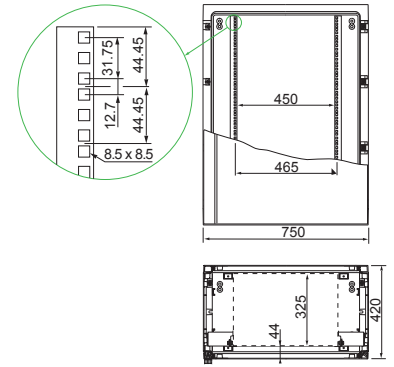

**Note:**  
Dimensions, see [page 225](#)



NSYBRF8PLAG

Characteristics	Height (mm)	Width (mm)	# of units	References
19" fixed chassis	500	750	8	<b>NSYBRF8PLAG</b>
19" fixed chassis	750	750	12	<b>NSYBRF12PLAG</b>
19" fixed chassis	1000	750	17	<b>NSYBRF17PLAG</b>
19" fixed chassis	1250	750	21	<b>NSYBRF21PLAG</b>
19" fixed chassis	1500	750	26	<b>NSYBRF26PLAG</b>
19" fixed chassis	2000	750	2 x 17	2 x <b>NSYBRF17PLAG</b> + <b>NSYPTZ4</b>
Batch of two uprights	750	750	12	<b>NSYSPLA75</b>
Batch of two uprights	1000	750	17	<b>NSYSPLA100</b>
Batch of two uprights	1250	750	21	<b>NSYSPLA125</b>
Batch of two uprights	1500	750	26	<b>NSYSPLA150*</b>
Batch of two uprights	2000	750	2 x 17	2 x <b>NSYSPLA100</b>

\* Not compatible with **NSYCAAPVHD**.

## 19" swing chassis

**Installation:** For heights from 750 to 1500 mm, the installation requires ordering one batch of two matching uprights. If a chassis is installed in an enclosure with a greater height, it is necessary to use the suitable uprights for the size of the enclosure

- Very sturdy 19" metal chassis, designed for installation in enclosures with a width of 750 and 1250 mm.  
In the 1250 mm enclosure, the chassis is installed in the 750 mm part with an intermediate support, ref. **NSYSBPLA**.
- These chassis can be used as partial mounting plates in enclosures with higher than nominal height.
- Incompatible with the internal doors and the step slides.
- Swing chassis opening to 120° with 5 mm double bar key lock.
- Material: Galvanised steel
- Finish: Swing part: Epoxy polyester paint
- Colour: RAL 7035 grey (swing part only)
- Maximum load: 3 kg per unit

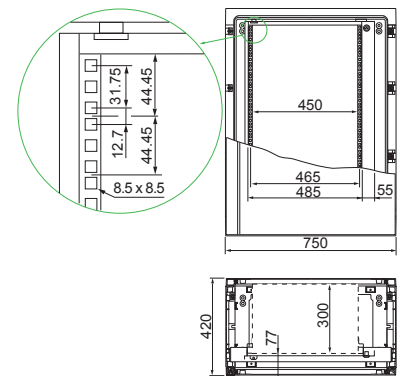

**Note:**  
Dimensions, see [page 225](#)



NSYBRP7PLAG



Characteristics	Height (mm)	Width (mm)	# of units	References
19" swing chassis	500	750	7	<b>NSYBRP7PLAG</b>
19" swing chassis	750	750	11	<b>NSYBRP11PLAG</b>
19" swing chassis	1000	750	16	<b>NSYBRP16PLAG</b>
19" swing chassis	1250	750	20	<b>NSYBRP20PLAG</b>
19" swing chassis	1500	750	25	<b>NSYBRP25PLAG</b>
19" swing chassis	2000	750	2 x 16	2 x <b>NSYBRP16PLAG</b>
Batch of two uprights	750	750	11	<b>NSYSPLA75</b>
Batch of two uprights	1000	750	16	<b>NSYSPLA100</b>
Batch of two uprights	1250	750	20	<b>NSYSPLA125</b>
Batch of two uprights	1500	750	25	<b>NSYSPLA150</b>
Batch of two uprights	2000	750	2 x 16	2 x <b>NSYSPLA100</b>

# Polyester floor-standing enclosures

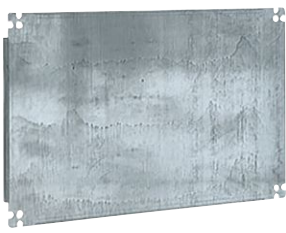

**Note:**  
Dimensions, see [page 223](#)

Metallic mounting plate					Insulating mounting plate													
Plain mounting plate					Telequick mounting plate													
<ul style="list-style-type: none"> <li>Direct installation on M8 inserts at the rear of the enclosure or on step slides for depth adjustment (see <a href="#">page 214</a>). The enclosures with height of <math>\geq 1000</math> mm have intermediate impressions for installing mounting plates of a lesser height (M8 inserts, ref. <b>NSYTEX8</b>, to be ordered separately).</li> <li>In the two door enclosures, it is possible to install one complete mounting plate or two individual mounting plates.</li> </ul>					<ul style="list-style-type: none"> <li>Grille with 11 x 26 mm drill holes, with a step of 15 x 30 mm, for direct installation, with clip nuts, of all the devices with fixing at 2, 3 or 4 points, by screws with diameters of 3, 4, 5 or 6 mm.</li> <li>Direct installation on M8 inserts at the rear of the enclosure or on step slides for depth adjustment (see <a href="#">page 214</a>). The enclosures with height of <math>\geq 1000</math> mm have intermediate impressions for installing mounting plates of a lesser height (M8 inserts, ref. <b>NSYTEX8</b>, to be ordered separately).</li> </ul>				<ul style="list-style-type: none"> <li>Direct installation on M8 inserts at the rear of the enclosure or on step slides for depth adjustment (see <a href="#">page 214</a>). The enclosures with height of <math>\geq 1000</math> mm have intermediate impressions for installing mounting plates of a lesser height (M8 inserts, ref. <b>NSYTEX8</b>, to be ordered separately).</li> <li>In the two door enclosures, it is possible to install one complete mounting plate or two individual mounting plates.</li> </ul>									
<b>Material</b>					Galvanised sheet steel				Galvanised steel				Bakelite			Polyester		
<b>Finish</b>					-				-				-			-		
<b>Colour</b>					-				-				-			-		
<b>Thickness</b>					2.5 mm				-				4 mm			<ul style="list-style-type: none"> <li>4 mm up to 700 mm height</li> <li>5 mm from 800 mm height</li> </ul>		
<b>Maximum load</b>					150 kg/m <sup>2</sup>				150 kg/m <sup>2</sup>				100 kg/m <sup>2</sup>			100 kg/m <sup>2</sup>		
<b>Supply</b>					One mounting plate				One mounting plate				One mounting plate			One mounting plate		
Dimensions					Dimensions													
Height (A) (mm)	Width (B) (mm)	H (mm)	Surface (dm <sup>2</sup> )	References	E (mm)	D (mm)	Surface (dm <sup>2</sup> )	References	References	References	References							
500	500	-	14	<b>NSYPMM55</b>	350	350	13	<b>NSYPMR55</b>	<b>NSYPMB55</b>	<b>NSYPMA55</b>								
500	750	-	24	<b>NSYPMM75</b>	350	600	23	<b>NSYPMR57</b>	<b>NSYPMB75</b>	<b>NSYPMA75</b>								
500	1000	437.5	32	<b>NSYPMM510</b>	350	2 x 350	26	2 x <b>NSYPMR55</b>	<b>NSYPMB510</b>	<b>NSYPMA510</b>								
500	1250	-	38	<b>NSYPMM55 + NSYPMM75</b>	350	350 + 600	36	<b>NSYPMR55 + NSYPMR57</b>	<b>NSYPMB55 + NSYPMB75</b>	<b>NSYPMA55 + NSYPMA75</b>								
750	500	-	24	<b>NSYPMM75</b>	600	350	23	<b>NSYPMR75</b>	<b>NSYPMB75</b>	<b>NSYPMA75</b>								
750	750	-	40	<b>NSYPMM77</b>	600	600	38	<b>NSYPMR77</b>	<b>NSYPMB77</b>	<b>NSYPMA77</b>								
750	1000	437.5	54	<b>NSYPMM710</b>	600	2 x 350	46	2 x <b>NSYPMR75</b>	<b>NSYPMB710</b>	<b>NSYPMA710</b>								
750	1250	687.5	70	<b>NSYPMM712</b>	600	350 + 600	61	<b>NSYPMR75 + NSYPMR77</b>	<b>NSYPMB712</b>	<b>NSYPMA712</b>								
1000	500	-	33	<b>NSYPMM105</b>	850	350	32	<b>NSYPMR105</b>	<b>NSYPMB105</b>	<b>NSYPMA105</b>								
1000	750	-	55	<b>NSYPMM107</b>	850	600	54	<b>NSYPMR107</b>	<b>NSYPMB107</b>	<b>NSYPMA107</b>								
1000	1000	437.5	74	<b>NSYPMM1010</b>	850	2 x 350	64	2 x <b>NSYPMR105</b>	<b>NSYPMB1010</b>	<b>NSYPMA1010</b>								
1000	1250	687.5	96	<b>NSYPMM1012</b>	850	350 + 600	86	<b>NSYPMR105 + NSYPMR107</b>	<b>NSYPMB1012</b>	<b>NSYPMA1012</b>								
1250	500	-	42	<b>NSYPMM125</b>	1100	350	42	<b>NSYPMR125</b>	<b>NSYPMB125</b>	<b>NSYPMA125</b>								
1250	750	-	70	<b>NSYPMM127</b>	1100	600	70	<b>NSYPMR127</b>	<b>NSYPMB127</b>	<b>NSYPMA127</b>								
1250	1000	437.5	96	<b>NSYPMM1210</b>	1100	2 x 350	84	2 x <b>NSYPMR125</b>	<b>NSYPMB1210</b>	<b>NSYPMA1210</b>								
1250	1250	687.5	124	<b>NSYPMM1212</b>	1100	350 + 600	112	<b>NSYPMR125 + NSYPMR127</b>	<b>NSYPMB1212</b>	<b>NSYPMA1212</b>								
1500	500	-	51	<b>NSYPMM155</b>	1350	350	51	<b>NSYPMR155</b>	<b>NSYPMB155</b>	-								
1500	750	-	85	<b>NSYPMM157</b>	1350	600	85	<b>NSYPMR157</b>	<b>NSYPMB157</b>	-								
1500	1000	437.5	118	<b>NSYPMM1510</b>	1350	2 x 350	102	2 x <b>NSYPMR155</b>	<b>NSYPMB1510</b>	-								
1500	1250	687.5	152	<b>NSYPMM1512</b>	1350	350 + 600	136	<b>NSYPMR155 + NSYPMR157</b>	<b>NSYPMB1512</b>	-								
2000	750	-	115	<b>NSYPMM207</b>	2 x 850	2 x 600	108	2 x <b>NSYPMR107</b>	2 x <b>NSYPMB107</b>	2 x <b>NSYPMA107</b>								

Side mounting plates			Partial plain mounting plate		Technical uprights		Anti burglary accessory	
								
<ul style="list-style-type: none"> <li>• Polyester mounting plates fixed to the sides of the enclosure for additional installations. Installation on the M8 bosses by adding inserts, ref. <b>NSYTEX8</b>.</li> </ul>			<ul style="list-style-type: none"> <li>• Direct fixing on the uprights, with the notched sliding nuts or pivoting nuts, see common accessories section.</li> </ul>		<ul style="list-style-type: none"> <li>• Supports for fixing rails, perforated grilles and plain partial mounting plates.</li> <li>• Details in the common accessory section.</li> <li>• Fixing at the rear on the M8 inserts or on the step slides.</li> </ul>		<ul style="list-style-type: none"> <li>• Anti burglary accessory for polyester outdoor Heavy Duty in accordance with ENV 1627-1630:2011 Class II. It keeps the Insulation Class II according to IEC 61439-1:2011.</li> </ul>	
Polyester			Galvanised sheet steel		Zinc-coated steel		Steel with anti-corrosive coating	
-			-		-		Structured finish, 100 % polyester powder	
-			-		-		RAL 7035 grey	
<ul style="list-style-type: none"> <li>• 4 mm up to 750 mm height</li> <li>• 5 mm from 800 mm height</li> </ul>			2.5 mm		2 mm		-	
100 kg/m <sup>2</sup>			150 kg/m <sup>2</sup>					
Reference by unit. Order by multiples of 2			One mounting plate		Two technical uprights		One anti burglary frame	
Enclosure depth 320 mm	Enclosure depth 420 mm	Enclosure depth 620 mm	Height 247 mm (H)	Height 397 mm (H)			Depth 420 mm	Depth 620 mm
References	References	References	References	References	Dimensions (mm)	References	References	References
NSYPMLA53	NSYPMLA54	-	-	-	-	-	-	-
NSYPMLA53	NSYPMLA54	-	NSYSPMP2575	-	-	-	-	-
NSYPMLA53	NSYPMLA54	-	NSYSPMP25100	NSYSPMP40100	-	-	-	-
NSYPMLA53	NSYPMLA54	-	-	-	-	-	-	-
NSYPMLA73	NSYPMLA74	-	-	-	625	NSYTVR7	-	-
NSYPMLA73	NSYPMLA74	-	NSYSPMP2575	-	625	NSYTVR7	NSYBGN774HD	NSYBGN776HD
NSYPMLA73	NSYPMLA74	-	NSYSPMP25100	NSYSPMP40100	625	NSYTVR7	-	-
NSYPMLA73	NSYPMLA74	-	-	-	625	NSYTVR7	-	-
NSYPMLA103	NSYPMLA104	-	-	-	875	NSYTVR10	NSYBGN1054HD	-
NSYPMLA103	NSYPMLA104	-	NSYSPMP2575	-	875	NSYTVR10	NSYBGN1074HD	-
NSYPMLA103	NSYPMLA104	-	NSYSPMP25100	NSYSPMP40100	875	NSYTVR10	-	-
NSYPMLA103	NSYPMLA104	-	-	-	875	NSYTVR10	-	-
NSYPMLA123	NSYPMLA124	NSYPMLA126	-	-	1125	NSYTVR125	NSYBGN1254HD	-
NSYPMLA123	NSYPMLA124	-	NSYSPMP2575	-	1125	NSYTVR125	NSYBGN1274HD	NSYBGN1276HD
NSYPMLA123	NSYPMLA124	-	NSYSPMP25100	NSYSPMP40100	1125	NSYTVR125	-	-
NSYPMLA123	NSYPMLA124	-	-	-	1125	NSYTVR125	NSYBGN12124HD	NSYBGN12126HD
-	-	-	-	-	1375	NSYTVR15	-	-
-	-	-	NSYSPMP2575	-	1375	NSYTVR15	NSYBGN1574HD	NSYBGN1576HD
-	-	-	NSYSPMP25100	NSYSPMP40100	1375	NSYTVR15	-	-
-	-	-	-	-	1375	NSYTVR15	NSYBGN15124HD	NSYBGN15126HD
-	2 x NSYPMLA104	-	NSYSPMP2575	-	1875	2 x NSYTVR10	NSYBGN2074HD	-
Note: Enclosures with widths of 1000 and 1250 allow the installation of four uprights to integrate two mounting plates of 500 mm or of 500 and 750 mm.								

## Modular distribution chassis

- Chassis for modular switchgear, installed directly in the sealed enclosures (PLA version).  
For installation in enclosures with open bottom part (PLAZ version) it is necessary to use a set of adapter plates (ref. **NSYPTZ●●●**).
- Chassis made up of cover plates on a rigid structure.
- Quick installation without fixings.
- Distance between rail and front panel with adjustable depth from 40 to 85 mm.
- System for identifying electrical circuits supplied.
- Neutral/earth strip: 2 x 16 mm<sup>2</sup> + 5 x 6 mm<sup>2</sup> included in the standard offer.
- Incompatibility with: Cable entry plate, internal door, door switch and door retainer (ref. **NSYRETPLAU**).
- Material: Rigid structure: Galvanised steel, Cover plates: Self-extinguishing insulating
- Colour: Cover plates: RAL 7035 grey

**Note:**  
Dimensions, see [page 213](#)  
Other modular distribution accessories on [page 214](#)



Dimensions (mm)		No. of doors	No. of rows	Rows for module	No. of modules 18 mm	No. of plates	References
Height (A)	Width (B)						
750	500	1	4	4	76	-	NSYDLP76G
750	500	1	4	3	57	1	NSYDLP57G
750	750	1	4	4	132	-	NSYDLP132G
750	750	1	4	3	99	1	NSYDLP99G
750	1000	2	4 + 4	4 + 4	152	-	2 x NSYDLP76G
750	1000	2	4 + 4	3 + 3	114	1 + 1	2 x NSYDLP57G
750	1250	2	4 + 4	4 + 4	208	-	NSYDLP76G + NSYDLP132G
750	1250	2	4 + 4	3 + 3	156	1 + 1	NSYDLP57G + NSYDLP99G
1000	500	1	6	6	114	-	NSYDLP114G
1000	500	1	6	5	95	1	NSYDLP95G
1000	750	1	6	6	198	-	NSYDLP198G
1000	750	1	6	5	165	1	NSYDLP165G
1000	1000	2	6 + 6	6 + 6	228	-	2 x NSYDLP114G
1000	1000	2	6 + 6	5 + 5	190	1 + 1	2 x NSYDLP95G
1000	1250	2	6 + 6	6 + 6	312	-	NSYDLP114G + NSYDLP198G
1000	1250	2	6 + 6	5 + 5	260	1 + 1	NSYDLP95G + NSYDLP165G
1250	500	1	7	7	133	-	NSYDLP133G
1250	500	1	7	6	114	1	NSYDLP114PG
1250	750	1	7	7	231	-	NSYDLP231G
1250	750	1	7	6	198	1	NSYDLP198PG
1250	1000	2	7 + 7	7 + 7	266	-	2 x NSYDLP133G
1250	1000	2	7 + 7	6 + 6	228	1 + 1	2 x NSYDLP114PG
1250	1250	2	7 + 7	7 + 7	364	-	NSYDLP133G + NSYDLP231G
1250	1250	2	7 + 7	6 + 6	312	1 + 1	NSYDLP114PG + NSYDLP198PG
1500	500	1	9	9	171	-	NSYDLP171G
1500	500	1	9	8	152	1	NSYDLP152G
1500	750	1	9	9	297	-	NSYDLP297G
1500	750	1	9	8	264	1	NSYDLP264G
1500	1000	2	9 + 9	9 + 9	342	-	2 x NSYDLP171G
1500	1000	2	9 + 9	8 + 8	304	-	2 x NSYDLP152G
1500	1250	2	9 + 9	9 + 9	468	1 + 1	NSYDLP171G + NSYDLP297G
1500	1250	2	9 + 9	8 + 8	416	1 + 1	NSYDLP152G + NSYDLP264G

## Modular distribution chassis

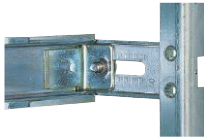
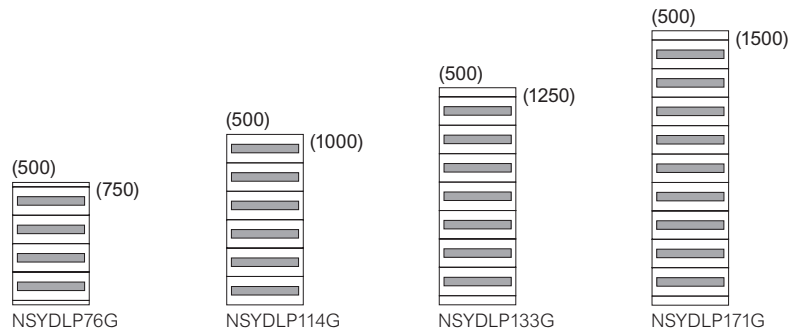

Details of the depth adjustment

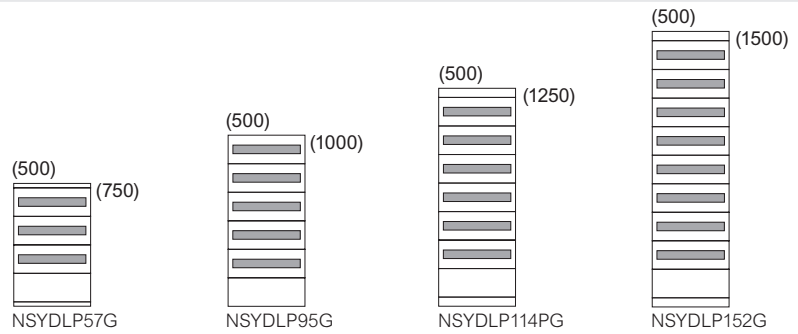

Detail from front panel mounting.

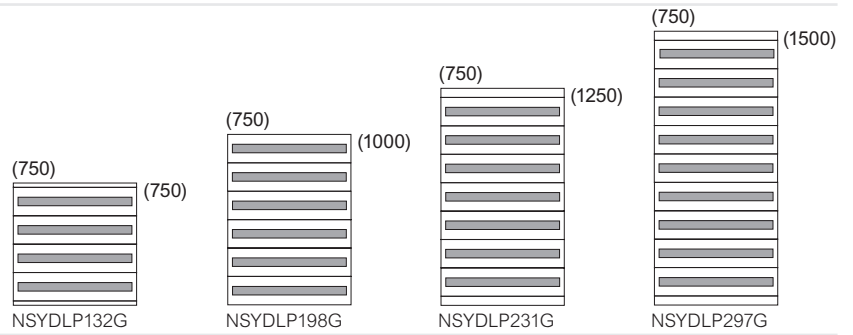

Detail from the circuitmarking system.

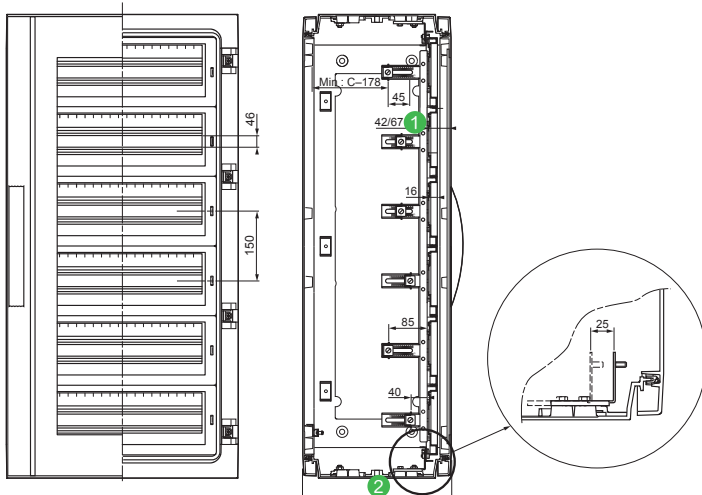
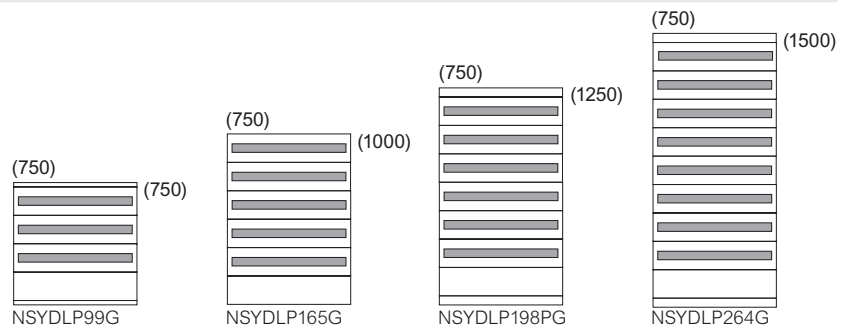

- 1 Dimensions of 42 or 67 mm or a pitch of 25 mm, according to the M8 boss chosen for the installation. See details in the enlarged image on the right. In the enclosures with glazed doors, the two dimensions are reduced by 5 mm.
- 2 C = Depth of the enclosure.

## Step slides

- Set of four step slides with brackets allowing continuous depth adjustment of the mounting plate, with a pitch of 25 mm.
- Designed for direct installation in the enclosures with sealed bottom part (versions PLA or PLAT).
- In the enclosures with open bottom part (versions PLAZ or PLAZT), installation is made possible by adding the relevant adapter plates.
- Incompatibility with: Internal door, modular distribution chassis, 19" chassis, cableentry plate and door retainer, ref. **NSYRETPLAU**.
- Material: Bracket with steel M8 stud on aluminium rail
- Fixing: Fixing on the top and bottom parts of the enclosure by means of M8 inserts and screws (supplied)



**Note:**  
Dimensions, see [page 223](#)



NSYDPLA3

Characteristics	Depth (mm)	No. of doors	References
Step slides	320	1	<b>NSYDPLA3</b>
Step slides	320	2	2 x <b>NSYDPLA3</b>
Step slides	420	1	<b>NSYDPLA4</b>
Step slides	420	2	2 x <b>NSYDPLA4</b>
Step slides	620	1	<b>NSYDPLA6</b>
Step slides	620	2	2 x <b>NSYDPLA6</b>

## Adapter plates

- The enclosures with open bottom part (versions PLAZ and PLAZT) require a set of adapter plates for mounting: An internal door, step slides, modular chassis and 19" chassis.
- **NSYPTZ●●●** for one door enclosures
- **NSYPTX●●● 2P** for two door enclosures
- Material: Galvanised steel
- Fixing: Fixing on the bottom part of the enclosure by means of M8 inserts and screws (supplied)



NSYPTZ3

Characteristics	Depth (mm)	No. of doors	References
Adapter plates	320	1	<b>NSYPTZ3</b>
Adapter plates	320	2	<b>NSYPTZ32P</b>
Adapter plates	420	1	<b>NSYPTZ4</b>
Adapter plates	420	2	<b>NSYPTZ42P</b>
Adapter plates	620	1	<b>NSYPTZ6</b>
Adapter plates	620	2	<b>NSYPTZ62P</b>

## Additional support

- Set of four additional brackets, to be slid into the step slides, for the installation of an additional mounting plate.



NSYEDPLA

Characteristics	Reference
Additional support	<b>NSYEDPLA</b>

9

## Plain cover plate

- Plain cover plate for non modular switchgear protection.
- Can be cutted out according to needs.
- Material: Polystyrene (PS) (for 146 mm high)
- Fiberglass reinforced polyester (for 298 mm high)
- Colour: RAL 7035 grey

**Supply:**  
Order by multiples of 2 (2, 4, 6...)

**Note:**  
Dimensions, [page 224](#)



NSYCTL500DLPG

Characteristics	References
Plain cover plate	<b>NSYCTL500DLPG</b>
Plain cover plate	<b>NSYCTL500DLP2</b>
Plain cover plate	<b>NSYCTL750DLPG</b>
Plain cover plate	<b>NSYCTL750DLP2</b>

## Plain mounting plate

- Plate for fixing non modular devices.
- Depth-adjustable fixing on the supports from 40 to 85 mm..
- Material: Galvanised steel 2 mm thick

**Supply:**  
Order by multiples of 2 (2, 4, 6...)

**Note:**  
Dimensions, [page 224](#)

Characteristics	References
Plain mounting plate	<b>NSYPMP500DLP</b>
Plain mounting plate	<b>NSYPMP5002DLP</b>
Plain mounting plate	<b>NSYPMP750DLP</b>
Plain mounting plate	<b>NSYPMP7502DLP</b>

Technical changes reserved. Information provided without guarantee. Images are for illustrative purposes only.

## Support plate



NSYSPLA75

### Installation:

It is installed directly on the bottom part of the enclosure.

For the installation of one or several support plates, use two sets of two uprights suitable for the height (to be ordered separately). These uprights offer the option of adjusting the height with a step of 50 mm

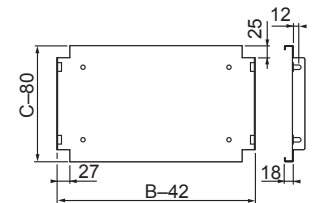
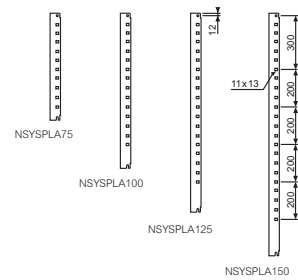

- Designed to support assorted equipment or simply to install a separation.
- In the two door enclosures, the installation of the plate or the uprights requires the prior installation of an intermediate support, ref. **NSYSBPLA**, presented beside.
- Material: Galvanised steel

### Supply:

Delivered with the fixings required for installation

Height	Depth	Upright No. of adjustments	References
750	320 / 420	2	2 x <b>NSYSPLA75</b>
1000	320 / 420	3	2 x <b>NSYSPLA100</b>
1250	320 / 420	4	2 x <b>NSYSPLA125</b>
1500	-	5	2 x <b>NSYSPLA150</b>

Depth (C)	Width (B)	Plate Max. load	References
320	500	60 kg	<b>NSYBANPLA53</b>
320	750	60 kg	<b>NSYBANPLA73</b>
420	500	50 kg	<b>NSYBANPLA54</b>
420	750	50 kg	<b>NSYBANPLA74</b>
620	500	50 kg	<b>NSYBANPLA56*</b>
620	750	50 kg	<b>NSYBANPLA76</b>

\*Designed for PLA enclosures of 1250 mm width and 620 mm depth.

## M8 inserts



NSYTEX8

- To be placed in the bosses moulded on the doors, uprights, rear panels and bottom and top parts, for fixing accessories and assorted devices.
- Material: Brass

### Supply:

References by unit. Order by multiples of 8 units (8, 16, 24, etc.)

Characteristics	References
Fixing inserts	<b>NSYTEX8</b>

## Intermediate support in the two door enclosures



NSYSBPLA

- Required accessory for installing support plates, ref. **NSYBANPLA●●●** or uprights, ref. **NSYSPLA●●●** in the two door enclosures
- Material: Galvanised steel

### Supply:

Two support kits

Characteristics	References
Intermediate support in the two door enclosures	<b>NSYSBPLA</b>

### Recommendation

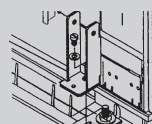

### Intermediate support

Accessory required for installing uprights, ref. **NSYSPLA●●●**. Only for two door enclosures.  
Supply: one (including two supports) ref. **NSYSBPLA**

Technical changes reserved. Information provided without guarantee. Images are for illustrative purposes only.